



STORZ & BICKEL



Crafty+

INSTRUCTIONS FOR USE

Read carefully before using the device
and save these instructions.

Table of Contents	page
1 Product Overview CRAFTY+	5
1.1 Scope of Delivery.....	5
1.2 Functional Elements.....	6
1.3 Service.....	7
2 For your Safety	9
2.1 Symbols	8
2.2 Explanation of Signs.....	8
2.3 Basic Rules	10
2.4 Safety Recommendations	10
2.4.1 Risk of Injury due to electric Shock.....	10
2.4.2 Danger of Injury due to Burning/Vapors ...	11
2.4.3 Risk of Injury due to various Causes.....	11
3 Intended Use	12
4 Overview of Plants	12
5 Factors influencing Vaporization	13
6 Commissioning and Operation	14
6.1 Unpacking.....	14
6.2 Power Connection	14
6.3 Charging the Battery	14
6.4 Filling the Filling Chamber	15
6.5 Heating Up.....	15
6.5.1 Default Settings.....	15
6.5.2 Basic Temperature.....	16
6.5.3 Booster Temperature	16
6.5.4 Superbooster Temperature	16
6.6 Application.....	16
6.7 End of Application.....	17
6.8 Automatic Switching Off	17
6.9 Storage	17

Table of Contents	page
7 Cleaning	18
7.1 Cooling Unit	18
7.1.1 Product Overview	18
7.1.2 Disassembling	18
7.1.3 Cleaning	20
7.1.4 Reassembling	20
7.2 Screens	21
7.3 Filling Chamber	21
7.3.1 Removing the lower Screen	21
7.3.2 Cleaning	21
7.3.3 Installing the lower Screen	21
7.4 Vaporizer and USB-C Cable	21
8 Storz & Bickel App	22
8.1 Default Settings	22
8.2 Connecting the Vaporizer with a Smartphone	22
8.3 Menu Items of the Storz & Bickel App	22
8.4 Setting Temperature with the Storz & Bickel App	23
8.5 Further individual Settings	24
8.6 Reset to Default Settings	24
9 Optional Accessories	27
9.1 Herb Mill	26
9.2 Filling Aid	26
9.2.1 Filling the Filling Aid	26
9.2.2 Filling the Filling Chamber with the Filling Aid	27

Table of Contents		page
9.3	Dosing Capsules (for single Use) and Magazin ...	27
9.3.1	Filling the Dosing Capsules	27
9.3.2	Filling the Magazine with Dosing Capsules.....	28
9.3.3	Inserting the Dosing Capsule into the Cooling Unit	28
10	Faults	29
10.1	Possible Faults / Troubleshooting.....	29
10.2	In Case of Faults.....	29
10.3	Disposal.....	29
11	Technical Specifications	30
12	Compliance with legal and normative Requirements	30
13	Warranty, Liability	31
13.1	Warranty	31
13.2	Liability	31
13.3	Copyright.....	32

1 PRODUCT OVERVIEW CRAFTY+

1.1 Scope of Delivery

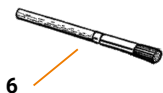
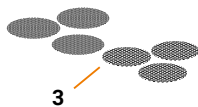
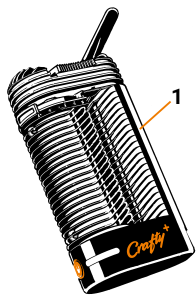

- | | | | |
|---|--|---|-------------------------------------|
| 1 | CRAFTY+ Vaporizer | 5 | 1 pc. Dosing Capsule |
| 2 | 1 pc. USB-C Cable | 6 | 1 pc. Cleaning Brush |
| 3 | 3 pcs. Normal Screen, small
3 pcs. Coarse Screen, small | 7 | 1 pc. Instruction for Use (concise) |
| 4 | 3 pcs. Base Seal Ring, small | | |

1 PRODUCT OVERVIEW CRAFTY+

1.2 Functional Elements

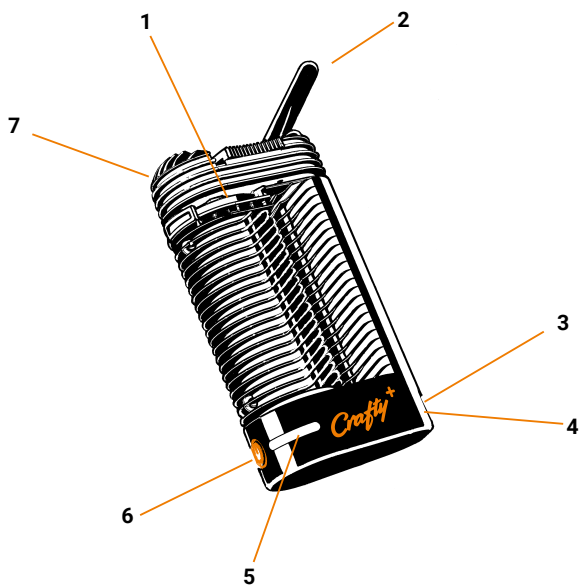

- | | | | |
|---|--|---|----------------|
| 1 | Filling Chamber | 5 | LED-Display |
| 2 | Mouthpiece | 6 | EON/OFF Switch |
| 3 | Filling Chamber Tool | 7 | Cooling Unit |
| 4 | USB-C Charging Socket
(behind the Filling Chamber Tool) | | |

1.3 Service

Please check whether all components have been included. If not, please inform the Storz & Bickel Service Center.

In the case of technical problems, questions about the device, warranty claims and disposal of the device, customers in the US and Canada should contact the following address:

Storz & Bickel America, Inc.

1078 60th Street, Suite A
Oakland, CA 94608

All other customers should contact this address:





Storz & Bickel GmbH

In Grubenäcker 5-9
78532 Tuttlingen, Germany

For service inquiries, please start an RMA (Return merchandise authorization) via our home page: www.storz-bickel.com/rma.

2 FOR YOUR SAFETY

2.1 Symbols

	Bullet points
	Hazard symbol
	Operating instructions
	Note

2.2 Explanation of Signs



Please follow these instructions carefully!



Symbol for the manufacturer - the manufacturer's name and address are next to the symbol



The device was introduced after 13 August 2005. It may not be disposed of in normal household waste. The X on the trash can indicates the necessity of disposing of this device separately. The device contains a built-in rechargeable lithium-ion battery that must be discharged before disposal.



EU conformity symbol: The manufacturer confirms with this symbol the compliance of the product with the applicable European directives and standards.

2 FOR YOUR SAFETY



Safety tested and production monitored by TUEV SUED according to EN 60335-1, UL 499 and CAN/CSA-22.2 No. 64-M91.



Safety tested and production monitored by TUEV SUED according to EN 60335-1.



Caution! Hot surfaces!
Do not touch metal parts!



Protect from direct sunlight.



Protect against moisture and humidity.



Symbol for serial number - followed by the serial number of the product



Symbol for order number



DC (direct current)



Safety Category II device

2 FOR YOUR SAFETY

2.3 Basic Rules

- ▶ These Instructions for Use are an integral part of the Vaporizer and must be made available to the user.
- ▶ Download the current detailed version of the Instructions for Use from www.storz-bickel.com.
- ▶ Read these instructions carefully and completely before operating the Vaporizer and USB-C Cable.
- ▶ Always follow the instructions in these Instructions for Use when using and servicing the device.
- ▶ This Vaporizer may be used by children of 8 years of age and older, and by persons with reduced physical, sensory or mental abilities or lack of experience and knowledge, if they are supervised or instructed in the safe use of the device and understand the possibility of resulting hazards. Do not allow children to play with the Vaporizer. Cleaning and user maintenance must not be carried out by children without supervision.
- ▶ If the user is suffering from respiratory tract or lung disease, the device may only be used after consultation and with the consent of the treating physician. Depending on their density, the vapors may irritate the respiratory tract and lungs, which may cause coughing.
- ▶ Do not operate the Vaporizer unattended.

- ▶ Store and use the Vaporize and USB-C Cable only at a sufficient distance from heat sources (oven, stove, fireplace, etc.) and in a dry place where the ambient temperature cannot drop below +5 °C (+41 °F).
- ▶ Do not expose the Vaporizer to extreme fluctuations in ambient temperature. Condensation humidity could interfere with the functionality.
- ▶ Only use original Storz & Bickel accessories and spare parts.
- ▶ Do not use the Vaporizer and USB-C Cable in an inappropriate, incorrect or unreasonable manner, as the manufacturer does not accept any responsibility for any damage resulting from this.

2.4 Safety Recommendations

2.4.1 Risk of Injury due to electric Shock

- ▶ The Vaporizer and USB-C Cable must be switched off and disconnected from the power supply after use, before any maintenance work and during thunderstorms.
- ▶ Make sure that the USB-C Cable is not damaged by bending, crushing or pulling.
- ▶ Do not use multiple sockets and/or extension cables. Where absolutely necessary, use only products with a quality certificate (e.g. UL,

2 FOR YOUR SAFETY

IMQ, VDE, +S, etc.) if the stated power value exceeds the power requirements (A=Ampere) of the connected devices.

- ▶ Do not use the Vaporizer and USB-C Cable if they are damaged. Repairs may only be carried out by our Service Center. Attempting to repair damage yourself will invalidate the warranty. Our Service Center will replace a defective USB-C Cable.
- ▶ The Vaporizer and USB-C Cable must not be exposed to moisture and humidity.
- ▶ Keep the Vaporizer and USB-C Cable away from pets (e.g. rodents) and pests.
- ▶ Do not use the Vaporizer and USB-C Cable in a potentially explosive or flammable atmosphere.

2.4.2 Danger of Injury due to Burning/Vapors

- ▶ Do not touch hot surfaces of the Vaporizer (filling chamber) during operation and the cooling phase.
- ▶ Place the hot Vaporizer only on a solid and heat-resistant surface and make sure that it is not covered.
- ▶ Do not use the Vaporizer near inflammable objects such as curtains, tablecloths or paper.
- ▶ Do not close, cover or obstruct the openings of the Vaporizer during operation and the cooling phase.

- ▶ Before switching on the Vaporizer, ensure that all vapors, e.g. from flammable cleaning agents and disinfectants, have evaporated.

2.4.3 Risk of Injury due to various Causes

- ▶ Be careful that small parts of the Vaporizer are not swallowed.
- ▶ Be aware of the danger of strangulation through the USB-C Cable.
- ▶ Only use the Vaporizer with the recommended herbs and plant parts to be vaporized. The use of other substances may cause poisoning or fire.
- ▶ Monitor your symptoms (e.g., cough, shortness of breath, chest pain) during or after the usage and promptly seek medical attention if you have concerns about your health.

3 INTENDED USE

The Vaporizer is used to produce fragrances or aromas from the herbs and plant parts listed in Chapter 4. The scents and aromas are released by means of vaporization with hot air and can be inhaled directly.

The Vaporizer is not for medical-therapeutic purposes.

4 OVERVIEW OF PLANTS

- ▶ Only vaporize fragrances and aromas from the plant materials listed here and which have been tested for authenticity, purity and pathogens according to the guidelines of the European Pharmacopoeia (or comparable).
- ▶ Purchase these plants or plant parts in your pharmacy.
- i** The Vaporizer is not intended for the use of tobacco or nicotine-related products.
- i** Any other use is inappropriate and potentially dangerous.

Plant name	Botanical name	Portion of the plant used	Temperature setting
Eucalyptus	<i>Eucalyptus globulus</i>	the leaves	130°C (266°F)
Hops	<i>Humulus lupulus</i>	the cones	154°C (309°F)
Chamomile	<i>Matriarca chamomilla</i>	the blossoms	190°C (374°F)
Lavender	<i>Lavandula angustifolia</i>	the blossoms	130°C (266°F)
Lemon balm	<i>Melissa officinalis</i>	the leaves	142°C (288°F)
Sage	<i>Salvia officinalis</i>	the leaves	190°C (374°F)
Thyme	<i>Thymus vulgaris</i>	the herb	190°C (374°F)

5 FACTORS INFLUENCING VAPORIZATION

Please follow these instructions so that you can adjust the Vaporizer with the plant material you use to suit your personal needs.

The amount of aromas and fragrances released can be influenced by the following factors:

1. **Quality:** The amount of aroma or fragrance contained in the respective plant material that can be vaporized.
2. **Quantity:** The amount of vaporization material in the filling chamber.
3. **Surface:** The finer the plant is ground, the greater the surface and the more aromas and fragrances can be released during the vaporization cycle.
4. **Temperature:** The higher the temperature, the more aromas and scents are released at once. An increase in temperature should always be a last resort, as the plant material has a more burnt taste at higher temperatures.

You can repeat the vaporization process with the same contents of the filling chamber until vapor is no longer produced at maximum temperature. For the sake of flavor, however, it is recommended that you replace the vaporization material beforehand.

6 COMMISSIONING AND OPERATION

6.1 Unpacking

- ▶ Check the Vaporizer according to Chapter 1.1 "Scope of Delivery", page 5 for completeness.

6.2 Power Connection

- ▶ Check the Vaporizer and the USB Cable for externally visible damage. Never operate a damaged Vaporizer.
- ▶ In case of doubt, have the electrical system checked by a specialist to ensure compliance with local safety regulations.

6.3 Charging the Battery

The battery charge of the new product has a level of up to 80%.

- ▶ Fully charge the battery before first use.
- ▶ Connect the USB-C Cable to the USB-C charging socket of the Vaporizer and the power source.

i The charging process is acknowledged with a short illumination of the LED display (short green/red/blue) and vibration.

i The battery charge status is signaled by the blue light on the LED display.

Explanations on the battery display during the charging operation:

- ▶ Steady blue light: the battery is fully charged.

- ▶ Blue, slow-flashing light: the battery is between 61 and 96% charged.
- ▶ Blue, rapidly flashing light: the battery is between 31 and 60% charged.
- ▶ Blue flashing: the battery is up to 30% charged.

Explanations of the battery display following switch off:

- ▶ Steady blue light: the battery is between 64 and 100% charged.
- ▶ Blue, slow-flashing: the battery is between 32 and 63% charged.
- ▶ Blue, rapidly flashing: the battery is between 1 and 31% charged.
- ▶ Blue flashing: the battery is completely discharged.

When charging is complete, disconnect the USB-C Cable from the power source first and then disconnect it from the Vaporizer.

i You cannot operate the Vaporizer while it is connected to a power source with the USB-C Cable. You can only switch it on again after it has been partially charged.

i You can also charge the battery using the optional 12 V Car Charger.

- ▶ Connect the 12 V Car Charger to the nominal voltage socket of the Vaporizer and then to a suitable 12 V socket or cigarette lighter.

6 COMMISSIONING AND OPERATION

NOTICE

Loss of warranty / damage to property if the battery is replaced independently

If the Vaporizer is opened improperly, it will be damaged.

- **Battery replacement only by our Service Center**

- ▶ Fill the filling chamber completely with ground plant material up to the plastic edge.

i Excessively compressed plant material or an overfilled filling chamber makes inhalation more difficult.

- ▶ Remove excess plant material around the filling connection.
- ▶ Put the Cooling Unit on the Vaporizer by turning it 90° clockwise.

6.4 Filling the Filling Chamber

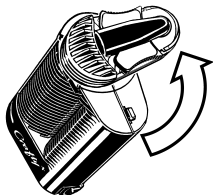

- ▶ Unscrew the Cooling Unit from the Vaporizer by turning it 90° counter-clockwise.

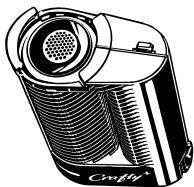

6.5 Heating Up

6.5.1 Default Settings

The Vaporizer offers three factory pre-set temperature levels:

- Basic temperature: 180 °C (356 °F)
- Booster temperature: + 15 °C (27 °F) (in relation to the basic temperature) corresponds to 195 °C (383 °F)
- Superbooster temperature: +30 °C (54 °F) (in relation to the basic temperature) corresponds to 210 °C (410 °F)

i The temperature levels for the base and booster temperature can be adjusted using a smartphone and the Storz & Bickel App. See Chapter 8 "Storz & Bickel App", page 22.

i If a particular temperature level is no longer sufficient, change to the next level as described below.

6 COMMISSIONING AND OPERATION

6.5.2 Basic Temperature

- ▶ Press the orange ON/OFF switch for at least half a second.

i A vibration acknowledges activation and the red continuous light of the LED display indicates heating. When the battery is fully charged, it takes approx. 60-80 seconds to heat up. A double vibration and green continuous light indicate that the basic temperature has been reached.

6.5.3 Booster Temperature

- ▶ Activate the booster temperature by double-clicking the orange ON/OFF switch.

i When the LED display flashes red, it indicates that the unit is heating up. A double vibration and green flashing signal that the booster temperature has been reached.

i Booster mode ends automatically 90 seconds after the booster temperature has been reached; the set temperature is then the basic temperature again.

6.5.4 Superbooster Temperature

- ▶ Activate the super booster temperature by clicking three times on the orange ON/OFF switch.

i The LED display indicates heating by flashing rapidly red. A double vibration and rapidly flashing green light signal that the super-booster temperature has been reached.

i Superbooster mode ends automatically 90 seconds after the booster temperature has been reached; the set temperature is then the basic temperature again.

6.6 Application



i Start the vaporization after heating has finished.

- ▶ Unfold the Mouthpiece of the Cooling Unit.

- ▶ Place the Mouthpiece between your lips.

- ▶ Breathe in evenly for a few seconds, but only half as much as you actually can.

- ▶ Hold your breath for a few seconds and then exhale slowly.

- ▶ Focus consciously on the breathing process.

i The more intense the vapors, the greater the impairment of the flavor.

6 COMMISSIONING AND OPERATION



CAUTION

Health problems due to inhalation of vapor

Coughing

- **Do not use if suffering from respiratory tract/lung diseases**

6.7 End of Application



CAUTION

Hot surface of the filling chamber

Caution! Hot surface!

- **Do not touch the filling chamber until the Vaporizer has cooled down.**

- ▶ Press the orange ON/OFF switch for at least half a second.

- i** The Vaporizer acknowledges the switching off with a vibration.

- ▶ Allow the Vaporizer to cool completely off.

6.8 Automatic Switching Off

- i** To conserve battery capacity, the Vaporizer will turn off automatically two minutes after the last key press or usage. The shutdown is confirmed by a vibration and display of the charge level.

- i** The automatic switch off can be reset to two minutes by briefly pressing the ON/OFF switch during operation.

6.9. Storage

Store the Vaporizer and USB-C Cable in a dry place away from the elements and out of reach of children or unqualified persons.

7 CLEANING

7.1 Cooling Unit

- i** Cooling Unit and Mouthpiece must be free of deposits. These are caused by steam condensate inside the Cooling Unit. For this reason, please check the Cooling Unit and Mouthpiece before each use.
- i** Clean the Cooling Unit including the mouthpiece regularly and when used by more than one person. Cleanliness is a prerequisite for proper function, for proper function and taste.

7.1.1 Product Overview

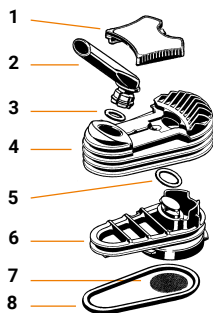

- 1 Cap Lock
- 2 Mouthpiece
- 3 Mouthpiece Seal Ring
- 4 Cooling Unit Cap
- 5 Base Seal Ring (small)
- 6 Cooling Unit Base
- 7 Upper Screen (coarse mesh width)
- 8 Base Seal Ring (large)

7.1.2 Disassembling

- i** A heated Cooling Unit is easier to disassemble because the steam condensate can be sticky.

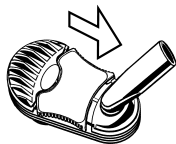

- ▶ Pull the cap lock towards the Mouthpiece.



- ▶ Pull the Cooling Unit Cap from the Vaporizer.



- ▶ Pull the Mouthpiece out of the Cooling Unit Cap by tilting it slightly back and forth.
- ▶ Pull off the Mouthpiece Seal Ring

7 CLEANING



- ▶ When cleaning the Cooling Unit Cap in isopropyl alcohol, remove the Cap Lock by pulling it up on one side.
- i** The signet hologram on the cap lock is a sticker.

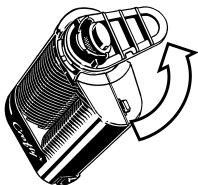

- ▶ Unscrew the Cooling Unit Base from the Vaporizer by turning it 90° counterclockwise.

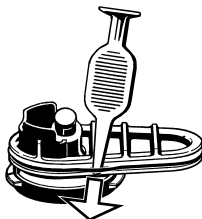

- ▶ Lever out the large Base Seal Ring with the Filling Chamber Tool at the recess in the groove.
- ▶ Remove the small Base Seal Ring.

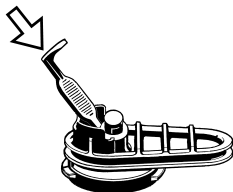

- ▶ Press the upper Screen with the Filling Chamber Tool from the top to the bottom out of the Cooling Unit base.

7 CLEANING

7.1.3 Cleaning



CAUTION

Isopropyl alcohol is flammable and may easily ignite.

Caution! Hot surface!

• **Follow the safety instructions of the isopropyl alcohol manufacturer!**

- i** The Cleaning Brush, cotton swabs and paper or cotton cloths are suitable for manual cleaning. We recommend warm rinsing water or isopropyl alcohol as solvents.

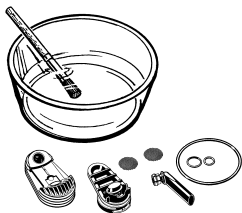

- ▶ Place all parts of the Cooling Unit (except the Cap Lock) and the Filling Chamber Screen in isopropyl alcohol for a maximum of 1/2 hour.
- i** Prolonged contact with isopropyl alcohol can lead to color changes or embrittlement of the plastic parts.
- ▶ Allow all parts to dry thoroughly.

- ▶ Check all parts for damaged surfaces, cracking, softening, hardening, soiling or discoloration.
- ▶ Remove any damaged parts.
- ▶ If necessary, clean the cap lock with warm rinse water or wipe it with isopropyl alcohol.

NOTICE

Material damage caused by improper cleaning

Stickers with the signet hologram may fade and their adhesive may dissolve

• **Avoid prolonged contact with isopropyl alcohol**

- i** Do not put the optional accessories including the Herb Mill, Filling Aid and Magazine in isopropyl alcohol. Clean these parts in the dishwasher, or with warm rinsing water.

7.1.4 Reassembling

- ▶ Assemble the parts in reverse order.
- i** When assembling, make sure that Seal Rings are properly seated. The small Base Seal Ring, especially, must sit completely in the Cooling Unit Cap and be no longer visible.
- ▶ Carefully insert the upper Acreen into the groove provided.

7 CLEANING

i Disregarding this may allow plant particles to enter the Cooling Unit, so blocking this or be inhaled.

7.2 Screens

▶ After each vaporization, clean the Screens with the enclosed Cleaning Brush.

7.3 Filling Chamber

i It is necessary to clean the filling chamber as soon as the lower Screen is clogged.

7.3.1 Removing the lower Screen

▶ Remove the lower Screen by pressing it along the groove in the filling chamber using the Filling Chamber Tool. This causes the lower Screen to bulge and detach from the groove.

7.3.2 Cleaning

▶ Clean the filling chamber with a cotton swab soaked in isopropyl alcohol.

i Make sure that no isopropyl alcohol drips into the interior of the device.

7.3.3 Installing the lower Screen

▶ Curve the lower Screen. |
▶ Insert the lower Screen into the filling chamber with the curved side facing upwards.

▶ Using the Filling Chamber Tool, press the screen flat into the provided groove.

7.4 Vaporizer and USB-C Cable

NOTICE

Material damage caused by improper cleaning

Water may penetrate and damage the Vaporizer or USB-C Cable

- Do not immerse in water or other liquids
- Do not clean with a direct water or steam jet or compressed air

▶ Disconnect the USB-C Cable from the power source.
▶ Switch off the Vaporizer.
▶ Clean the housing of the Vaporizer and the USB-C Cable only dry or at most with a damp cloth if necessary.

8 STORZ & BICKEL APP

The Storz & Bickel App is not necessary for operating the Vaporizer, does however allow individual settings to be made and allows the readout of additional information when the Vaporizer is in operation.

As the Vaporizer has too little space for a display, the Vaporizer can be connected to a smartphone via **Bluetooth®** and the smartphone's display used.

The availability of the Storz & Bickel App depends on the operating system.

8.1 Default Settings

Basic temperature: 180°C (356°F)

Booster temperature: +15°C (27°F)
(in relation to the basic temperature),
corresponds to: 195°C (383°F)

Superbooster temperature:
+15°C (27°F)
(in relation to the basic temperature),
corresponds to: 210°C (410°F)

LED indicator brightness
CRAFTY+: 100%

Charge indicator lamp CRAFTY+: ON

Vibration CRAFTY+: ON

Vibration smartphone: OFF

Smartphone alarm tone: OFF

8.2 Connecting the Vaporizer with a Smartphone

- ▶ Download the Storz & Bickel App.

- ▶ Make sure that the **Bluetooth®** function is switched on and that it is not occupied by another **Bluetooth®** device.

- ▶ Switch on the Vaporizer.

- ▶ Start the Storz & Bickel App.

- ▶ Enter the serial number (=six-digit alphanumeric string on the type plate at the bottom of the device and prefix (CP or CY)) of your Vaporizer.

i When the Storz & Bickel App is subsequently started up, the two devices connect automatically.

i If another CRAFTY+ Vaporizer is to be controlled by the same smartphone, disconnect the previous connection using the „Disconnect“ button and enter the serial number of the other CRAFTY+ Vaporizer.

8.3 Menu Items of the Storz & Bickel App

Temperature

This function allows you to read the set and actual temperatures and change your temperature settings. You will also find the charge indicator of the Vaporizer.

Device

Device-related information such as operating hours, software versions etc. can be viewed here.

Information

Here you will find further information such as the list of plants, the Quick Start Manual, the Instructions for Use, the general Terms and Conditions, the data protection declaration, as well as direct links to the Storz & Bickel website or to the online shop.

8.4 Setting Temperature with the Storz & Bickel App

i In addition to the three factory-set temperature levels, you can also individually set temperatures between 40°C and 210°C (104 °F) and 410 °F) (see Chapter 4). "Overview of Plants", page 12).

- ▶ Briefly press the upper plus button to increase the target value in 1-degree increments.
- ▶ Briefly press the upper minus button to decrease the target value in 1-degree increments.
- ▶ Press the plus or minus button continuously so that the target values run continuously in the corresponding direction.

i The current actual temperature can be read from the upper line of the display.

i The booster or superbooster temperature is always added to the base or booster temperature. In addition, the degree difference between basic temperature and booster temperature can be ad-

justed to the degree using the lower plus and minus keys. The difference in degrees between booster and superbooster temperature is fixed and is always +15°C (27°F). But the total cannot exceed 210°C (410°F).

Fahrenheit/Celsius

- ▶ Touch the plus and minus buttons simultaneously to change the display from degrees Celsius to degrees Fahrenheit.

Charge Indicator Lamp



- i** The charge indicator lamp shows a battery symbol with six fields indicating the charging status.
- ▶ Full battery: display of all six charging status fields.
 - ▶ Battery almost empty: flashing battery frame.
 - ▶ Charging: flashing charge display and display of the current charge level.

8.5 Further individual Settings

i The Storz & Bickel App can be used to make other useful setting changes, such as switching the vibration motor on and off, dimming or switching off the LED display, extending the automatic switch-off time, locating the Vaporizer on the App at the touch of a button and much more. Further information on the Storz & Bickel App can be found at:

<https://www.storz-bickel.com/eu/eng/app/>

8.6 Reset to Default Settings

Settings which you have changed via the Storz & Bickel App can be reset as follows:

- ▶ Switch on the Vaporizer.
- ▶ Press the ON/OFF switch for 10 seconds. The reset is acknowledged by the following running lights: red/green/blue/red/green/blue/red/green/blue and simultaneous vibration.

9 OPTIONAL ACCESSORIES

Wear & Tear Set - SKU 06 02 CY

The Wear & Tear Set contains all spare parts required to replace the Cooling Unit.

Cooling Unit Set - SKU 03 05 CY / Cooling Unit - SKU 03 04 CY

Replace the Cooling Unit regularly to ensure cleanliness.

Mouthpiece Set - SKU 11 11

The Set includes four Mouthpieces for the Cooling Unit.

Screen Set, small - SKU 11 12

The Set contains four Screens with coarse mesh width for the Cooling Unit and two Screens with normal mesh width for the filling chamber.

Coarse Screen Set, small - SKU 11 40

The Set includes six coarse mesh Screens for the Cooling Unit.

Normal Screen Set, small - SKU 11 03

The Set includes four normal mesh Screens for the filling chamber.

Seal Ring Set - SKU 06 01 CY

The Set contains all necessary Sealing Rings for the Cooling Unit and filling chamber.

Herb Mill - SKU 09 30 / Herb Mill XL - SKU 09 43

The Herb Mill has extra sharp cutting teeth for finely ground herbs.

Filling Aid - SKU 09 31 MC

The Filling Aid facilitates clean filling of the ground plant material into the filling chamber.

Filling Chamber Tool Set - SKU 11 19

The various application options of the Filling Chamber Tool are described in these Instructions for Use.

Filling Set for 40 Dosing Capsules - SKU 09 45

The Filling Set is designed for the simultaneous filling 40 Dosing Capsules with ground plant material.

12 Volt Car Charger - SKU 01 09 CY

Car Charger for battery charging

You can find these and other accessories as well as detailed information about these products under <https://www.storz-bickel.com> or contact our Service Center: 07461/969707-0.

9 OPTIONAL ACCESSORIES

9.1 Herb Mill



- ▶ Place plant material between the two mill bowls of the Herb Mill.
- ▶ Close the Herb Mill.
- ▶ Turn the Herb Mill back and forth 4-5 times.

9.2 Filling Aid

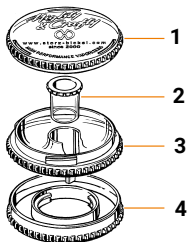

- 1 Upper Cap
- 2 Plug
- 3 Bowl
- 4 Lower Cap

- i** Use the Filling Aid for easy and clean filling of the filling chamber. You can store ground plant material in the bowl of the Filling Aid.

9.2.1 Filling the Filling Aid



- ▶ Unscrew the top lid counterclockwise.
- ▶ Fill the bowl incl. stopper with ground plant material.
- ▶ Put on the upper lid by turning it clockwise.

9.2.2 Filling the Filling Chamber with the Filling Aid

- ▶ Unscrew the Cooling Unit from the Vaporizer by turning it 90° counterclockwise.
- ▶ Use the Filling Chamber Tool to remove any residues from the filling chamber.
- ▶ Unscrew the lower lid of the Filling Aid clockwise.
- ▶ Put the Filling Aid on the Vaporizer by turning it 90° clockwise.
- ▶ Unscrew the top lid of the Filling Aid counterclockwise.
- ▶ Pull the plug out of the Filling Aid.

9 OPTIONAL ACCESSORIES



- ▶ Push a portion of plant material through the central opening into the filling chamber.
- i** Make sure that the filling chamber is not overfilled (see Chapter 6.4 "Filling the Filling Chamber", page 15).



- i** Fill the filling chamber only to the lower edge of the Filling Aid.
- ▶ Insert the plug into the central opening.
- ▶ Put on the upper lid by turning it clockwise.
- ▶ Unscrew the Filling Aid from the Vaporizer by turning it 90° counterclockwise.

- ▶ Put the lower lid on the Filling Aid by turning it counterclockwise.
- ▶ Put the Cooling Unit on the Vaporizer by turning it 90° clockwise.

9.3 Dosing Capsules (for single Use) and Magazin



- i** With the Dosing Capsules available as accessories, you can fill the ground plant material and store them in the magazin until use. That makes handling easier.
- i** The Dosing Capsules are disposable. After use, dispose of them in residual waste.
- i** The Magazin can hold up to eight Dosing Capsules.

9.3.1 Filling the Dosing Capsules



- ▶ Grind the plant material with the Storz & Bickel Herb Mill.

9 OPTIONAL ACCESSORIES

- ▶ Fill the Dosing Capsules using the Magazine Lid.
- ▶ Unscrew the Magazine Lid counterclockwise.
- ▶ Put the Magazine Lid on the open Dosing Capsule.



- ▶ Push a portion of plant material through the central opening into the Dosing Capsule.
- ▶ Close the Dosing Capsule with its lid.

9.3.2 Filling the Magazine with Dosing Capsules

- ▶ Insert the filled Dosing Capsules into the Magazine.



- ▶ Close the Magazine by turning the Magazine Lid clockwise.

9.3.3 Inserting the Dosing Capsule into the Cooling Unit



- ▶ Unscrew the Cooling Unit from the Vaporizer by turning it 90° counterclockwise.

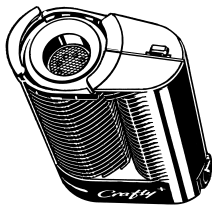

- ▶ Insert the Dosing Capsule with the lid facing up into the filling chamber of the Vaporizer.
- ▶ Put the Cooling Unit on the Vaporizer by turning it 90° clockwise.

10 FAULTS

10.1 Possible Faults / Troubleshooting

Fault	Possible Cause/Remedy
Vaporizer cannot be switched on.	Make sure that the battery is charged.
LED display flashes alternately red/blue.	Battery temperature is either too high or too low. Let the Vaporizer either cool down or warm up.
LED display flashes blue.	Battery is empty. Connect the Power Adapter or Car Charger.
LED display flashes alternately red/green.	The USB-C Cable is not suitable. Use the supplied USB-C Cable.
LED display flashes alternately red/orange.	The Vaporizer is faulty.

10.2 In Case of Faults

- i** Do not attempt to repair the damage yourself. This will void the warranty.
- ▶ Switch off the Vaporizer immediately.
- ▶ Disconnect the Vaporizer from the power source.
- ▶ Contact our Service Center directly.
- ▶ Send the defective Vaporizer to our Service Center for repair.

10.3 Disposal

- ▶ After the warranty period, dispose of an irreparable Vaporizer through the material cycle or send it to our Service Center for disposal.

11 TECHNICAL SPECIFICATIONS

CRAFTY+ Vaporizer:

Supply voltage: 5 V DC

The voltage specification can be found on the Vaporizer type plate:

Power required by Vaporizer: 10 W max.

Operating temperature: 5°C - 35°C / 41°F - 95°F

Vaporization Temperature:

adjustable between approx. 40°C - 210°C / 104°F - 410°F

Size: 11.0 x 5.7 x 3.3 cm (4.3 x 2.2 x 1.3 inch)

Weight: approx. 135 g (0.3 lb)

Subject to technical changes.

Patents and designs: www.storz-bickel.com/patents

12 COMPLIANCE WITH LEGAL AND NORMATIVE REQUIREMENTS

The devices comply with the following EC Directives:

- IEC 60335
- EN 55011
- EN 61000-4-X



Manufacturer:

Storz & Bickel GmbH
In Grubenäcker 5-9
78532 Tuttlingen, Germany

13 WARRANTY, LIABILITY

13.1 Warranty

Storz & Bickel GmbH and Storz & Bickel America Inc., as the sellers, hereby guarantee the customer, that the product will be free from defects in accordance with the specifications of German law, and pursuant to our General Terms and Conditions (GTC), upon which the purchasing agreement are based. Of course, Storz & Bickel will only be subject to a warranty obligation if the customer has purchased the products directly from us. If products are purchased from third parties, warranty claims may only be asserted against these third parties, and Storz & Bickel cannot provide any information on the content of such claims.

In clarification, we would like to note once again, that the warranty extends only to correcting such initial defects that exist despite proper handling of the product in consideration of this Instructions for Use and further information provided to users. Normal wear or tear to the products – and especially to the batteries - is not considered a defect under warranty law. If the customer has commissioned third parties with completing maintenance or repair of the product, or if the customer uses external products, Storz & Bickel's warranty obligations will only exist if the customer can prove that the defect was not caused by use of the external service or external product.

Storz & Bickel will decide at its own discretion whether to correct a defect covered by warranty law through repair or by delivering a new product to the customer.

Any warranty claims must be directed to Storz & Bickel GmbH, In Grubenäcker 5-9, 78532 Tuttlingen. American and Canadian customers should direct warranty claims to Storz & Bickel America Inc., 1078 60th Street, Suite A, Oakland, CA 94608. Please send the complete defective item to us, not disassembled, with invoice. Please use external packaging that would prevent any damage during transportation.

In order to avoid misunderstandings, we would like to note that all information on our products provided in this Instructions for Use or elsewhere does not represent any guarantee of features or durability, unless we have expressly referred to a guarantee for such features or durability.

13.2 Liability

Storz & Bickel shall be liable for any damages caused to the customer by our products in accordance with German law and pursuant to our GTC. Under said provisions, we are only liable for damages caused by intentional action or gross negligence, unless such damages involve death, personal injury, or injury to health, or if the injury is re-

13 WARRANTY, LIABILITY

lated to a cardinal contractual obligation. In such cases, we will also be liable to the customer for simple negligence.

13.3 Copyright

This document is copyright protected, and may not be used either in whole or in part pursuant to Sections 15 et seqq. UrhG (German Copyright Act) without prior written approval of Storz & Bickel.



STORZ & BICKEL

STORZ & BICKEL GmbH

In Grubenäcker 5-9 · 78532 Tuttlingen/Germany

